

■Features

- High Luminous LEDs
- 5.2x3.8mm Standard Directivity
- Superior Weather-resistance
- UV Resistant Epoxy
- Color Diffused Type

■Applications

- Automotive Dashboard Lighting
- Back Lighting
- Other Lighting

■Outline Dimension

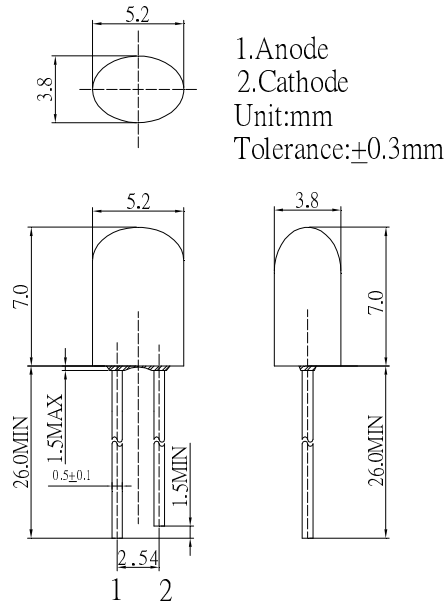

■Absolute Maximum Rating

(Ta=25°C)

Item	Symbol	Value	Unit
DC Forward Current	I _F	30	mA
Pulse Forward Current*	I _{FP}	100	mA
Reverse Voltage	V _R	5	V
Power Dissipation	P _D	108	mW
Operating Temperature	T _{opr}	-30 ~ +85	°C
Storage Temperature	T _{stg}	-40 ~ +100	°C
Lead Soldering Temperature	T _{sol}	260°C/5sec	-

*Pulse width Max.10ms Duty ratio max 1/10

■Directivity

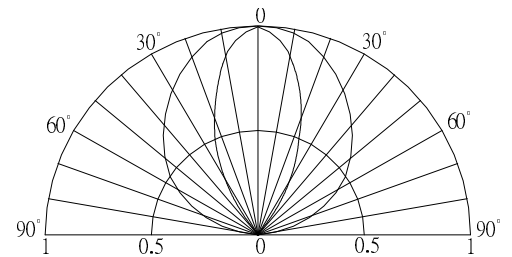

■Electrical -Optical Characteristics

(Ta=25°C)

Item	Symbol	Condition	Min.	Typ.	Max.	Unit
DC Forward Voltage	V _F	I _F =20mA	2.9	3.1	3.6	V
DC Reverse Current	I _R	V _R =5V	-	-	10	μA
Domi. Wavelength	λ _D	I _F =20mA	520	525	530	nm
Luminous Intensity	I _v	I _F =20mA	1560	2180	-	mcd
50% Power Angle	2θ _{1/2}	I _F =20mA	-	110/50	-	deg

*1 Tolerance of measurements of dominant wavelength is +1nm

*2 Tolerance of measurements of luminous intensity is +15%

*3 Tolerance of measurements of forward voltage is ±0.1V