

**■Features**

- High Luminous LEDs
- 3mm Round Standard Directivity
- Flashing Type
- Water Clear Type

**■Applications**

- Toys
- Games
- Audio
- Other Lighting

**■Outline Dimension**

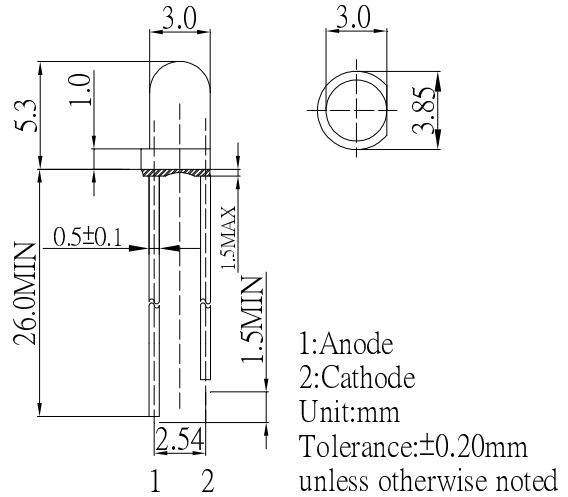

**■Absolute Maximum Rating**

(Ta=25°C)

Item	Symbol	Value	Unit
Power Supply	Voltage	5	V
Operating Temperature	Topr	-30 ~ +85	°C
Storage Temperature	Tstg	-40~ +100	°C
Lead Soldering Temperature	Tsol	260°C/5sec	-

**■Directivity**

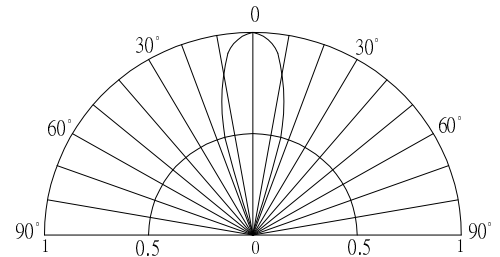

**■Electrical -Optical Characteristics**

(Ta=25°C)

Item	Symbol	Condition	Min.	Typ.	Max.	Unit
DC Forward Voltage	V <sub>dd</sub>	I <sub>F</sub> =20mA	3.0	3.3	5.0	V
Oscillator Frequency*	F <sub>led</sub>	I <sub>F</sub> =20mA	-	1.8	-	Hz
Duty Cycle	Duty	I <sub>F</sub> =20mA	-	1/2	-	-
Domi. Wavelength*	λ <sub>D</sub>	I <sub>F</sub> =20mA	585	590	595	nm
Luminous Intensity*	I <sub>v</sub>	I <sub>F</sub> =20mA	4200	5000	-	mcd
50% Power Angle	2θ <sub>1/2</sub>	I <sub>F</sub> =20mA	-	30	-	deg

\*1 Tolerance of measurements of dominant wavelength is +1nm

\*2 Tolerance of measurements of luminous intensity is +15%

\*3 Tolerance of measurements of frequency is +20%

\*4 Tolerance of measurements of forward voltage is +0.1V