

■ Features

- 5mm Round Standard Directivity
- Wide Input Voltage Range (DC3-15V)
- With Built-in Resistor, Direct Use
- Cost Effective (Saves Space and Resistor Cost)
- UV Resistant Epoxy
- Water Clear Type

■ Applications

- Toys/Game/Audio
- TTL/Cmos Compatible
- Arduino/Pi Pico/Steam Kit
- Other Electronics Products







■ Absolute Maximum Rating

(Ta=25°C)

Item	Symbol	Value	Unit
DC Forward Voltage	V _F	16	V
Reverse Voltage	V _R	12	V
Power Dissipation	P _D	208	mW
Operating Temperature	Topr	-30 ~ +85	°C
Storage Temperature	Tstg	-30~ +85	°C
Lead Soldering Temperature	Tsol	260°C/5sec	-

■ Electrical -Optical Characteristics

(Ta=25°C)

Part Number	Color			I _F (mA)*			I _v (mcd)*			λD(nm)*			2θ1/2(deg)
				Min	Typ.	Max.	Min.	Typ.	Max.	Min.	Typ.	Max.	Typ.
				V _F =9V			V _F =9V						
OSW54K5A31A-VVLED	White	W		-	7.5	13	-	5800	-	8500-18000K(X:0.27,Y:0.28)			30
OSM54K5A31A-VVLED	Warm White	M		-	7.5	13	-	4500	-	2700-3200K(X:0.45,Y:0.41)			30
OSB5DA5A31A-VVLED	Blue	B		-	7.5	13	-	2180	-	465	470	475	30
OSG58A5A31A-VVLED	Pure Green	G		-	7.5	13	-	5800	-	520	525	530	30
OSY5PA5A31A-VVLED	Yellow	Y		-	8	13	-	3000	-	585	590	595	30
OSO5PA5A31A-VVLED	Orange	O		-	8	13	-	3000	-	600	605	610	30
OSR5PA5A31A-VVLED	Red	R		-	8	13	-	3000	-	620	625	630	30

*1 Tolerance of measurements of domi. wavelength is ±1nm

*2 Tolerance of measurements of chromaticity coordinates is ±10%

*3 Tolerance of measurements of luminous intensity is ±15%

*4 Tolerance of measurements of forward voltage is ±0.1V

■ Outline Dimension

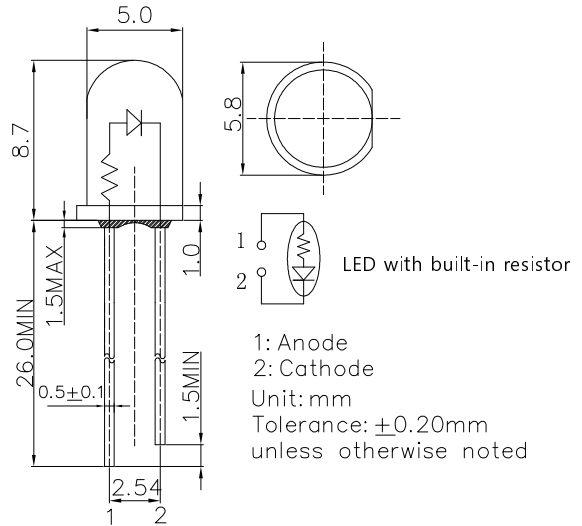

■ Directivity

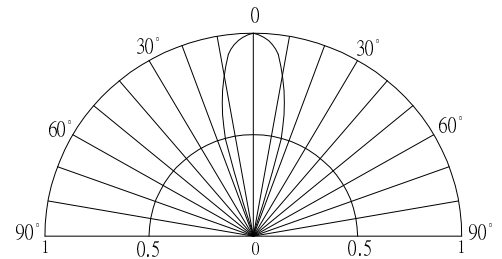

InGaN and Si Resistor LED

TYPICAL ELECTRICAL/OPTICAL CHARACTERISTIC CURVES

