

■Description

- This LED builds with internal resistor to operate with wide operation voltage of DC3-15V
- 50pcs are supplied in a storage box
- Easy to use and storage, user-friendly
- Widely applied to project design, Arduino/Pi Pico/Steam kit, TTL/Cmos compatible applications

■Product Picture

50pcs/Box (Dimensions: 67*49*23mm)



■Features

- Wide Input Voltage
- Cost Saving and Space Saving
- Red Diffused Type
- Red Color

■Applications

- Toys/Game/Audio
- TTL/Cmos Compatible
- Arduino/Pi Pico/Steam Kit
- Other Electronics Products

■Outline Dimension

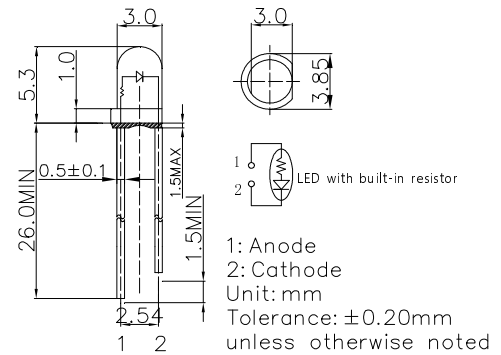

■Absolute Maximum Rating (Ta=25°C)

Item	Symbol	Value	Unit
DC Forward Voltage	V _F	15	V
Reverse Voltage	V _R	12	V
Power Dissipation	P _D	190	mW
Operating Temperature	T _{opr}	-30 ~ +85	°C
Storage Temperature	T _{stg}	-40~ +100	°C
Lead Soldering Temperature	T _{sol}	260°C/5sec	-

■Directivity

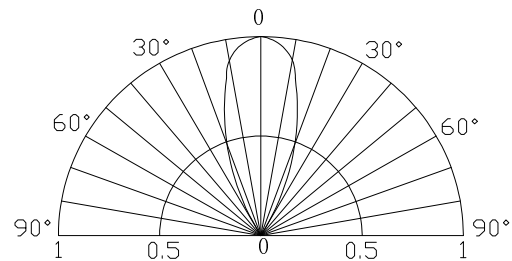

■Electrical -Optical Characteristics (Ta=25°C)

3mm Multi-Voltage LED	
LED P/N	OSR53144A-VV
Light Color	Red
Lens Color	Red Diffused
Wavelength*1	620-630nm
Luminous Intensity(typ.)*2	400mcd
Forward Voltage(typ.)	9V
Forward Current(typ.)*3	8mA
Viewing Angle(typ.)	40°
Quantity(pcs)/Box	50

*1 Tolerance of measurements of dominant wavelength is ±1nm
 *2 Tolerance of measurements of luminous intensity is ±15%
 *3 Tolerance of measurements of forward current ±1mA

■Optical Characteristic Curves

