

■ Description

- LED Kit contains 0402, 0603, 0805, 1206 single color chip LEDs & flashing type chip LEDs in 0805 single color, 0805 bi-color and 0807 Full Color RGB
- 440pcs are supplied in a storage box for easy storage
- Easy to use and storage
- Widely applied to DIY projects, school science experiments, car decorations, etc.

■ Features

- 0402/0603/0805/0807/1206 of surface mount 120° directivity
- Red/Yellow/Pure Green/Blue/Cool White/ Bi-Color /RGB
- R/Y/PG/B: Water clear, W: Yellow diffused

■ Product Picture

440pcs/Box (Dimensions: 148*106*17mm)



■ Kit Contents

Section	Contents	Pcs	P/N	Spec
1	0402 Chip LED, Red	20	OSR50402	Page 2
	0402 Chip LED, Yellow	20	OSY50402	
	0402 Chip LED, Blue	20	OSB50402	
	0402 Chip LED, Pure Green	20	OSG50402	
	0402 Chip LED, Cool White	20	OSW50402	
2	0603 Chip LED, Red	20	OSR50603	Page 3
	0603 Chip LED, Yellow	20	OSY50603	
	0603 Chip LED, Blue	20	OSB50603	
	0603 Chip LED, Pure Green	20	OSG50603	
	0603 Chip LED, Cool White	20	OSW50603	
3	0805 Chip LED, Red	20	OSR50805	Page 4
	0805 Chip LED, Yellow	20	OSY50805	
	0805 Chip LED, Blue	20	OSB50805	
	0805 Chip LED, Pure Green	20	OSG50805	
	0805 Chip LED, Cool White	20	OSW50805	
4	1206 Chip LED, Red	20	OSR51206	Page 5
	1206 Chip LED, Yellow	20	OSY51206	
	1206 Chip LED, Blue	20	OSB51206	
	1206 Chip LED, Pure Green	20	OSG51206	
	1206 Chip LED, Cool White	20	OSW51206	
5	0805 Flashing Chip LED, Cool White	10	OSW50805S	Page 6
	0805 Flashing Chip LED, Red & Blue	10	OSRB0805S	Page 7
	0807 Quick Flashing Chip LED, RGB	10	OSTC0807S	Page 8
	0807 Slow Flashing Chip LED, RGB	10	OSTA0807S	Page 9

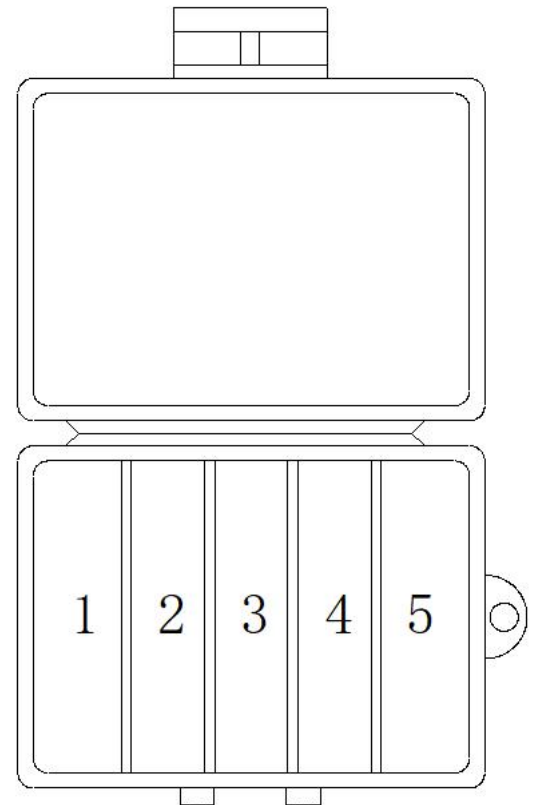

■Features

- Single chip
- Super high brightness of surface mount LED
- Sorting for I_v and V_f @ 5mA of I_f
- Compact package outline (LxWxT) of 1.0 x 0.5 x 0.4mm
- Compatible with automatic placement equipment.

■Applications

- Backlighting (switches, keys, etc.)
- Marker lights (e.g. steps, exit ways, etc.)

■Outline Dimension

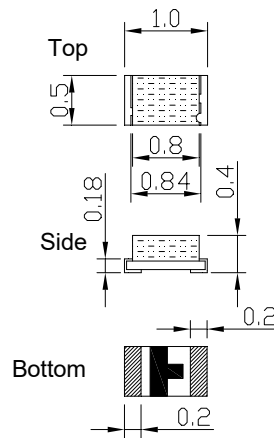

Recommended Solder Pad

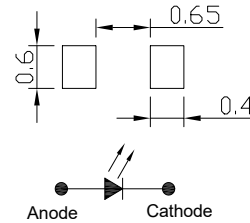

Notes: 1. All dimensions are in millimeters ;
2. Tolerance is ± 0.10 mm unless otherwise noted.

■Absolute Maximum Rating

($T_a=25^\circ\text{C}$)

Item	Symbol	Value		Unit
		R / Y	B/PG/W	
DC Forward Current	I_F	20	20	mA
Pulse Forward Current#	I_{FP}	100	100	mA
Reverse Voltage	V_R	5	5	V
Power Dissipation	P_D	46	66	mW
Operating Temperature	T_{opr}	-40 ~ +85		$^\circ\text{C}$
Storage Temperature	T_{stg}	-40 ~ +85		$^\circ\text{C}$
Lead Soldering Temperature	T_{sol}	260 $^\circ\text{C}$ /10sec		-

#Pulse width Max 0.1ms, Duty ratio max 1/10

■Electrical -Optical Characteristics

($T_a=25^\circ\text{C}$)

0402 Chip LED					
LED P/N	OSR50402	OSY50402	OSB50402	OSG50402	OSW50402
Light Color	Red	Yellow	Blue	Pure Green	Cool White
Lens Color	Water Clear	Water Clear	Water Clear	Water Clear	Yellow Diffused
Wavelength*1/Color Temperature*2	620-630nm	585-595nm	465-475nm	520-530nm	8500-18000K
Luminous Intensity(typ.)*3	35mcd	35mcd	30mcd	150mcd	150mcd
Forward Voltage*4	1.5-2.3V	1.5-2.3V	2.5-3.3V	2.5-3.3V	2.5-3.3V
Forward Current	5mA	5mA	5mA	5mA	5mA
Viewing Angle(typ.)	120 $^\circ$	120 $^\circ$	120 $^\circ$	120 $^\circ$	120 $^\circ$
Quantity(pcs)/Box	20	20	20	20	20

*1 Tolerance of measurements of dominant wavelength is ± 1 nm

*2 Tolerance of measurements of color temperature is $\pm 10\%$

*3 Tolerance of measurements of luminous intensity is $\pm 15\%$

*4 Tolerance of measurements of forward voltage is ± 0.1 V

■Directivity

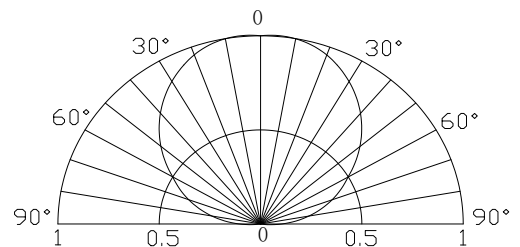

■Features

- Single chip
- Super high brightness of surface mount LED
- Sorting for I_v and V_f @ 5mA of I_f
- Compact package outline (LxWxT) of 1.6 x 0.8 x 0.6mm
- Compatible with automatic placement equipment.

■Applications

- Backlighting (switches, keys, etc.)
- Marker lights (e.g. steps, exit ways, etc.)

■Outline Dimension

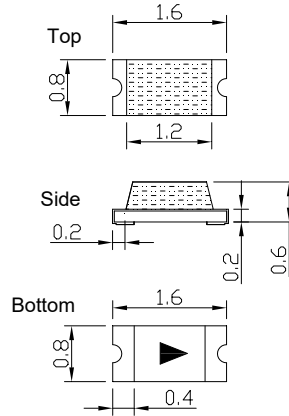

Recommended Solder Pad

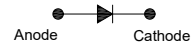
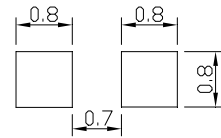

Notes: 1. All dimensions are in millimeters ;
2. Tolerance is ± 0.10 mm unless otherwise noted.

■Absolute Maximum Rating

($T_a=25^\circ\text{C}$)

Item	Symbol	Value		Unit
		R / Y	B/PG/W	
DC Forward Current	I_F	20	20	mA
Pulse Forward Current#	I_{FP}	100	100	mA
Reverse Voltage	V_R	5	5	V
Power Dissipation	P_D	46	66	mW
Operating Temperature	T_{opr}	-40 ~ +85		$^\circ\text{C}$
Storage Temperature	T_{stg}	-40 ~ +85		$^\circ\text{C}$
Lead Soldering Temperature	T_{sol}	260 $^\circ\text{C}$ /10sec		-

#Pulse width Max 0.1ms, Duty ratio max 1/10

■Electrical -Optical Characteristics

($T_a=25^\circ\text{C}$)

0603 Chip LED					
LED P/N	OSR50603	OSY50603	OSB50603	OSG50603	OSW50603
Light Color	Red	Yellow	Blue	Pure Green	Cool White
Lens Color	Water Clear	Water Clear	Water Clear	Water Clear	Yellow Diffused
Wavelength*1/Color Temperature*2	620-630nm	585-595nm	465-475nm	520-530nm	8500-18000K
Luminous Intensity(typ.)*3	35mcd	35mcd	30mcd	150mcd	150mcd
Forward Voltage*4	1.5-2.3V	1.5-2.3V	2.5-3.3V	2.5-3.3V	2.5-3.3V
Forward Current	5mA	5mA	5mA	5mA	5mA
Viewing Angle(typ.)	120 $^\circ$	120 $^\circ$	120 $^\circ$	120 $^\circ$	120 $^\circ$
Quantity(pcs)/Box	20	20	20	20	20

*1 Tolerance of measurements of dominant wavelength is ± 1 nm

*2 Tolerance of measurements of color temperature is $\pm 10\%$

*3 Tolerance of measurements of luminous intensity is $\pm 15\%$

*4 Tolerance of measurements of forward voltage is ± 0.1 V

■Directivity

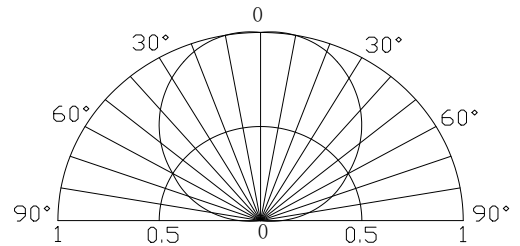

■Features

- Single chip
- Super high brightness of surface mount LED
- Sorting for I_v and V_f @ 10mA of I_f
- Compact package outline (LxWxT) of 2.0 x 1.25 x 0.8mm
- Compatible with automatic placement equipment.

■Applications

- Backlighting (switches, keys, etc.)
- Marker lights (e.g. steps, exit ways, etc.)

■Outline Dimension

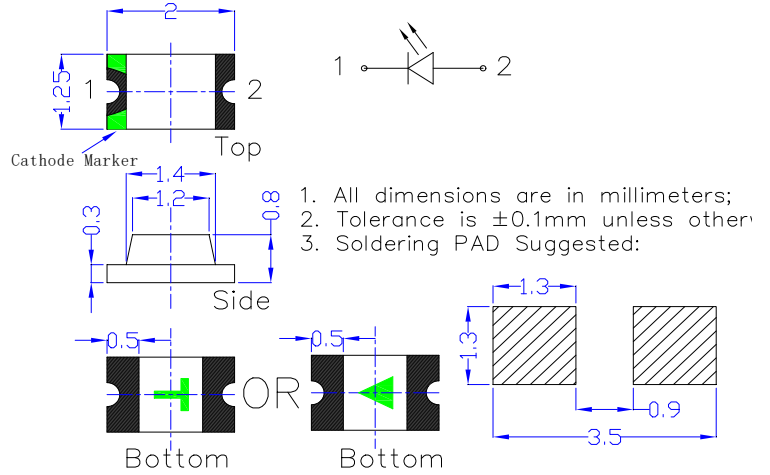

■Absolute Maximum Rating

($T_a=25^{\circ}\text{C}$)

Item	Symbol	Value		Unit
		R / Y	B/PG/W	
DC Forward Current	I_F	20	20	mA
Pulse Forward Current#	I_{FP}	100	100	mA
Reverse Voltage	V_R	5	5	V
Power Dissipation	P_D	48	68	mW
Operating Temperature	T_{opr}	-40 ~ +85		$^{\circ}\text{C}$
Storage Temperature	T_{stg}	-40 ~ +85		$^{\circ}\text{C}$
Lead Soldering Temperature	T_{sol}	260 $^{\circ}\text{C}$ /10sec		-

#Pulse width Max 0.1ms, Duty ratio max 1/10

■Directivity

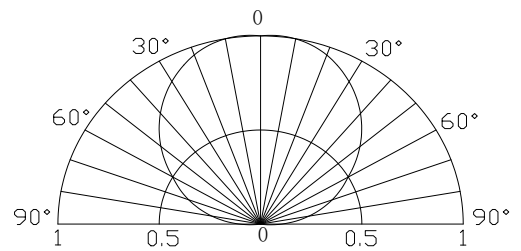

■Electrical -Optical Characteristics

($T_a=25^{\circ}\text{C}$)

0805 Chip LED					
LED P/N	OSR50805	OSY50805	OSB50805	OSG50805	OSW50805
Light Color	Red	Yellow	Blue	Pure Green	Cool White
Lens Color	Water Clear	Water Clear	Water Clear	Water Clear	Yellow Diffused
Wavelength*1/Color Temperature*2	620-630nm	585-595nm	465-475nm	520-530nm	8500-18000K
Luminous Intensity(typ.)*3	70mcd	70mcd	65mcd	250mcd	250mcd
Forward Voltage*4	1.6-2.4V	1.6-2.4V	2.6-3.4V	2.6-3.4V	2.6-3.4V
Forward Current	10mA	10mA	10mA	10mA	10mA
Viewing Angle(typ.)	120 $^{\circ}$	120 $^{\circ}$	120 $^{\circ}$	120 $^{\circ}$	120 $^{\circ}$
Quantity(pcs)/Box	20	20	20	20	20

*1 Tolerance of measurements of dominant wavelength is $\pm 1\text{nm}$

*2 Tolerance of measurements of color temperature is $\pm 10\%$

*3 Tolerance of measurements of luminous intensity is $\pm 15\%$

*4 Tolerance of measurements of forward voltage is $\pm 0.1\text{V}$

■Features

- Single chip
- Super high brightness of surface mount LED
- Sorting for I_v and V_f @ 10mA of I_f
- Compact package outline (LxWxT) of 3.2 x 1.6 x 0.8mm
- Compatible with automatic placement equipment.

■Applications

- Backlighting (switches, keys, etc.)
- Marker lights (e.g. steps, exit ways, etc.)

■Outline Dimension

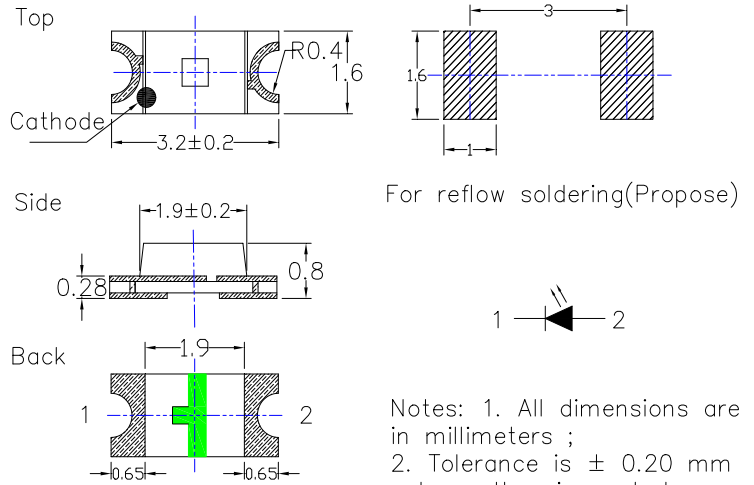

■Absolute Maximum Rating

($T_a=25^\circ\text{C}$)

Item	Symbol	Value		Unit
		R / Y	B/PG/W	
DC Forward Current	I_F	20	20	mA
Pulse Forward Current#	I_{FP}	100	100	mA
Reverse Voltage	V_R	5	5	V
Power Dissipation	P_D	48	68	mW
Operating Temperature	T_{opr}	-40 ~ +85		$^\circ\text{C}$
Storage Temperature	T_{stg}	-40 ~ +85		$^\circ\text{C}$
Lead Soldering Temperature	T_{sol}	260 $^\circ\text{C}$ /10sec		-

#Pulse width Max 0.1ms, Duty ratio max 1/10

■Electrical -Optical Characteristics

($T_a=25^\circ\text{C}$)

1206 Chip LED					
LED P/N	OSR51206	OSY51206	OSB51206	OSG51206	OSW51206
Light Color	Red	Yellow	Blue	Pure Green	Cool White
Lens Color	Water Clear	Water Clear	Water Clear	Water Clear	Yellow Diffused
Wavelength*1/Color Temperature*2	620-630nm	585-595nm	465-475nm	520-530nm	8500-18000K
Luminous Intensity(typ.)*3	70mcd	70mcd	65mcd	250mcd	250mcd
Forward Voltage*4	1.6-2.4V	1.6-2.4V	2.6-3.4V	2.6-3.4V	2.6-3.4V
Forward Current	10mA	10mA	10mA	10mA	10mA
Viewing Angle(typ.)	120 $^\circ$	120 $^\circ$	120 $^\circ$	120 $^\circ$	120 $^\circ$
Quantity(pcs)/Box	20	20	20	20	20

*1 Tolerance of measurements of dominant wavelength is ± 1 nm

*2 Tolerance of measurements of color temperature is $\pm 10\%$

*3 Tolerance of measurements of luminous intensity is $\pm 15\%$

*4 Tolerance of measurements of forward voltage is ± 0.1 V

■Directivity

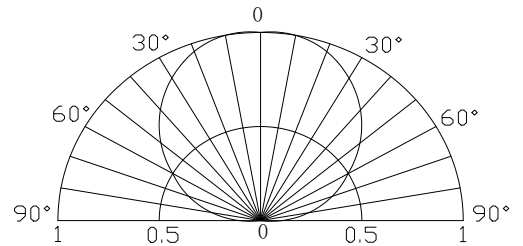

■Features

- Single chip flashing type
- 2.0x1.25x0.8mm(0805) standard package.
- Suitable for all SMT assembly methods.
- Compatible with infrared and vapor phase reflow solder process.
- This product doesn't contain restriction Substance, comply ROHS standard.
- Compatible with automatic placement equipment.

■Applications

- Automotive : Dashboards, stop lamps, turn signals.
- Backlighting : LCDs, Key pads advertising.

■Outline Dimension

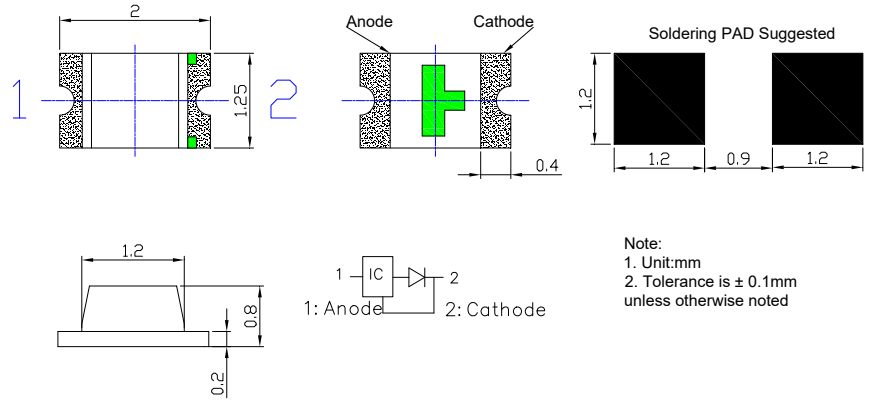

■Absolute Maximum Rating

(Ta=25°C)

Item	Symbol	Value	Unit
Power Supply	Voltage	5	V
Duty Cycle	Duty	1/2	-
Operating Temperature	Topr	-40 ~ +85	°C
Storage Temperature	Tstg	-40 ~ +85	°C
Lead Soldering Temperature	Tsol	260°C/10sec	-

■Directivity

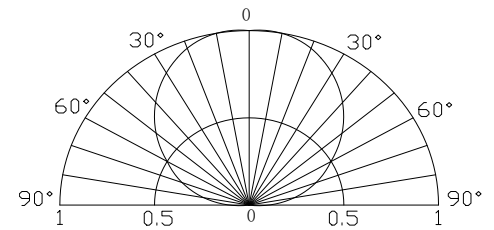

■Electrical -Optical Characteristics

(Ta=25°C)

Item	Symbol	Condition	Min.	Typ.	Max.	Unit
DC Forward Voltage*1	Vdd	I _F =20mA	3.0	3.5	5.0	V
Oscillator Frequency*2	Fled	I _F =20mA	-	1.5	-	Hz
Luminous Intensity*3	I _v	I _F =20mA	-	330	-	mcd
Color Temperature*4	CCT	I _F =20mA	8500	10000	18000	K
50% Power Angle	2θ _{1/2}	I _F =20mA	-	120	-	deg

*1 Tolerance of measurements of forward voltage is ±0.1V

*2 Tolerance of measurements of Frequency is ±20%

*3 Tolerance of measurements of luminous intensity is ±15%

*4 Tolerance of measurements of Color Temperature is ±10%

■Features

- Bi-color chip flashing type
- 2.0x1.25x0.8mm(0805) standard package.
- Suitable for all SMT assembly methods.
- Compatible with infrared and vapor phase reflow solder process.
- This product doesn't contain restriction Substance, comply ROHS standard.
- Compatible with automatic placement equipment.

■Applications

- Automotive : Dashboards, stop lamps, turn signals.
- Backlighting : LCDs, Key pads advertising.

■Outline Dimension

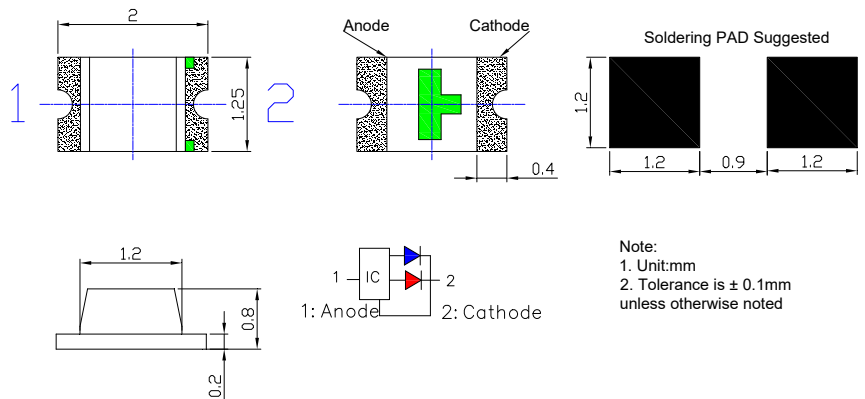

■Absolute Maximum Rating

(Ta=25°C)

Item	Symbol	Value	Unit
Power Supply	Voltage	5	V
Duty Cycle	Duty	1/2	-
Operating Temperature	Topr	-40 ~ +85	°C
Storage Temperature	Tstg	-40~ +85	°C
Lead Soldering Temperature	Tsol	260°C/10sec	-

■Directivity

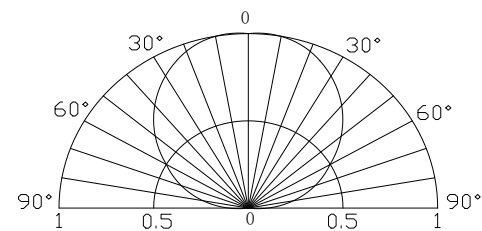

■Electrical -Optical Characteristics

(Ta=25°C)

Item	Symbol	Conditio	Min.	Typ.	Max.	Unit
DC Forward Voltage*1	V _{dd}	I _F =20mA	3.0	3.5	5.0	V
Oscillator Frequency*2	F _{led}	I _F =20mA	-	1.5	-	Hz
Duty Cycle	Duty	I _F =20mA	-	1/2	-	-
Domi. Wavelength*3	λ _D (Red)	I _F =20mA	620	625	630	nm
	λ _D (Blue)	I _F =20mA	460	465	470	nm
Luminous Intensity*4	I _v (Red)	I _F =20mA	-	100	-	mcd
	I _v (Blue)	I _F =20mA	-	100	-	mcd
50% Power Angle	2θ _{1/2}	I _F =20mA	-	120	-	deg

*1 Tolerance of measurements of forward voltage is ±0.1V

*2 Tolerance of measurements of Frequency is ±20%

*3 Tolerance of measurements of dominant wavelength is ±1nm

*4 Tolerance of measurements of luminous intensity is ±15%

■Features

- Full color flashing type
- 2.0x1.7x0.9mm(0807) standard package.
- Suitable for all SMT assembly methods.
- Compatible with infrared and vapor phase reflow solder process.
- This product doesn't contain restriction Substance, comply ROHS standard.
- Compatible with automatic placement equipment.

■Applications

- Automotive : Dashboards, stop lamps, turn signals.
- Backlighting : LCDs, Key pads advertising.

■Outline Dimension

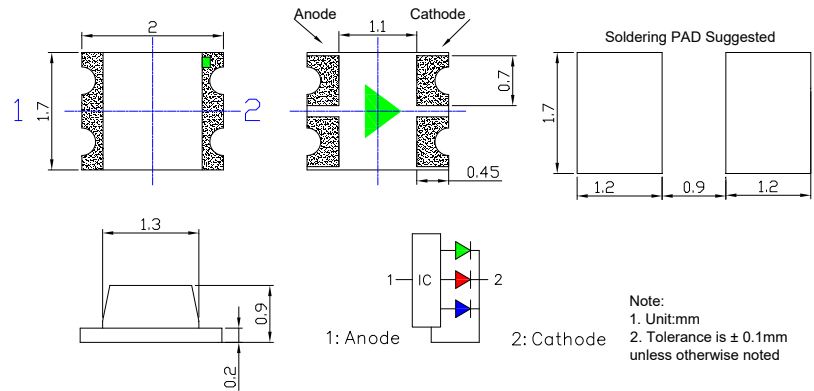

■Absolute Maximum Rating

(Ta=25°C)

Item	Symbol	Value	Unit
Power Supply	Voltage	5	V
Operating Temperature	Topr	-40 ~ +85	°C
Storage Temperature	Tstg	-40~ +85	°C
Lead Soldering Temperature	Tsol	260°C/10sec	-

■Directivity

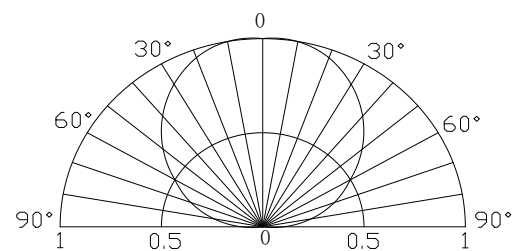

■Electrical -Optical Characteristics

(Ta=25°C)

Item	Symbol	Conditio	Min.	Typ.	Max.	Unit
DC Forward Voltage*1	Vdd	I _F =20mA	3.5	4.5	5.0	V
Oscillator Cycle*2	Fled	I _F =20mA	-	15	-	S
Domi. Wavelength*3	λ _D (R)	I _F =20mA	620	625	630	nm
	λ _D (PG)	I _F =20mA	520	525	530	nm
	λ _D (B)	I _F =20mA	460	465	470	nm
Luminous Intensity*4	I _v (R)	I _F =20mA	-	100	-	mcd
	I _v (PG)	I _F =20mA	-	400	-	mcd
	I _v (B)	I _F =20mA	-	100	-	mcd
50% Power Angle	2θ _{1/2}	I _F =20mA	-	120	-	deg

*1 Tolerance of measurements of forward voltage is ±0.1V

*2 Tolerance of measurements of oscillator cycle is ±20%

*3 Tolerance of measurements of dominant wavelength is ±1nm

*4 Tolerance of measurements of luminous intensity is ±15%

■Features

- Full color flashing type
- 2.0x1.7x0.9mm(0807) standard package.
- Suitable for all SMT assembly methods.
- Compatible with infrared and vapor phase reflow solder process.
- This product doesn't contain restriction Substance, comply ROHS standard.
- Compatible with automatic placement equipment.

■Applications

- Automotive : Dashboards, stop lamps, turn signals.
- Backlighting : LCDs, Key pads advertising.

■Outline Dimension

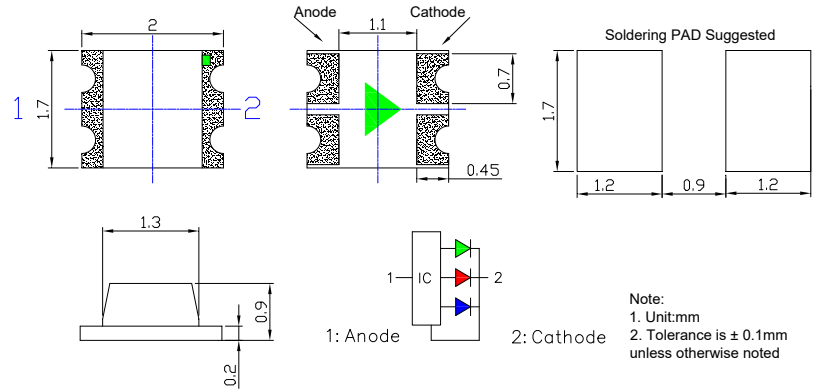

■Absolute Maximum Rating

(Ta=25°C)

Item	Symbol	Value	Unit
Power Supply	Voltage	5	V
Operating Temperature	Topr	-40 ~ +85	°C
Storage Temperature	Tstg	-40~ +85	°C
Lead Soldering Temperature	Tsol	260°C/10sec	-

■Directivity

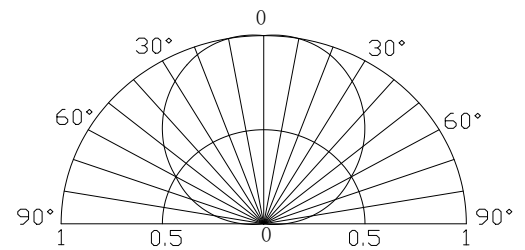

■Electrical -Optical Characteristics

(Ta=25°C)

Item	Symbol	Conditio	Min.	Typ.	Max.	Unit
DC Forward Voltage*1	Vdd	I _F =20mA	3.5	4.5	5.0	V
Oscillator Cycle*2	Fled	I _F =20mA	-	40	-	S
Domi. Wavelength*3	λ _D (R)	I _F =20mA	620	625	630	nm
	λ _D (PG)	I _F =20mA	520	525	530	nm
	λ _D (B)	I _F =20mA	460	465	470	nm
Luminous Intensity*4	I _v (R)	I _F =20mA	-	100	-	mcd
	I _v (PG)	I _F =20mA	-	400	-	mcd
	I _v (B)	I _F =20mA	-	100	-	mcd
50% Power Angle	2θ _{1/2}	I _F =20mA	-	120	-	deg

*1 Tolerance of measurements of forward voltage is ±0.1V

*2 Tolerance of measurements of oscillator cycle is ±20%

*3 Tolerance of measurements of dominant wavelength is ±1nm

*4 Tolerance of measurements of luminous intensity is ±15%