

■ Features

- High Luminous Small Package LED
- 3mm Concave Top Standard Directivity
- UV Resistant Epoxy
- Wide Operation Current 1-20mA
- Water Clear Type

■ Applications

- Small Area Illuminations
- Telephone
- Back Lighting
- General Use

■ Outline Dimension

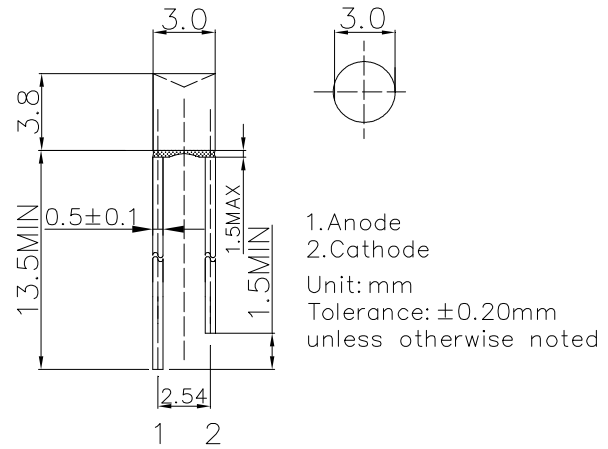

■ Absolute Maximum Rating

(Ta=25°C)

Item	Symbol	Value		Unit
		Y/O/R	W/M/B/PG	
DC Forward Current	I _F	20	20	mA
Pulse Forward Current#	I _{FP}	100	100	mA
Reverse Voltage	V _R	5	5	V
Power Dissipation	P _D	48	64	mW
Operating Temperature	Topr	-30 ~ +85		°C
Storage Temperature	Tstg	-40 ~ +100		°C
Lead Soldering Temperature	Tsol	260°C/5sec		-



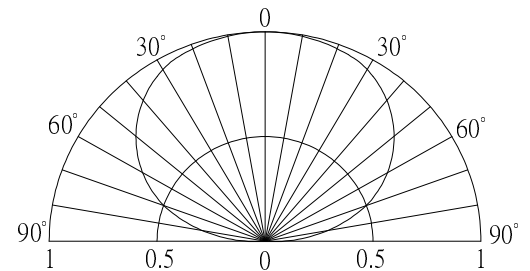



■ Directivity



#Pulse width Max.10ms Duty ratio max 1/10

■ Electrical -Optical Characteristics

(Ta=25°C)

Part Number	Color			V _F (V)			I _R (μA)	I _v (mcd)*			λD(nm)* / CCT(K)			2θ1/2(deg)
				Min.	Typ.	Max.	Max.	Min.	Typ.	Max.	Min.	Typ.	Max.	Typ.
				I _F =5mA			V _R =5V		I _F =5mA					
OSW54K3FE1F	Cool White	W		-	2.7	3.2	10	250	330	-	CCT:8500-18000K(X:0.27,Y:0.28)			140
OSM54K3FE1F	Warm White	M		-	2.7	3.2	10	250	330	-	CCT:2700-3300K(X:0.44,Y:0.41)			140
OSB5DA3FE1F	Blue	B		-	2.7	3.2	10	150	200	-	465	470	475	140
OSG58A3FE1F	Pure Green	PG		-	2.7	3.2	10	250	330	-	520	525	530	140
OSY5PA3FE1F	Yellow	Y		-	1.9	2.4	10	180	220	-	585	590	595	140
OSO5PA3FE1F	Orange	O		-	1.9	2.4	10	180	220	-	600	605	610	140
OSR5PA3FE1F	Red	R		-	1.9	2.4	10	180	220	-	620	625	630	140

*1 Tolerance of measurements of chromaticity coordinate is ±10%
 *2 Tolerance of measurements of dominant wavelength is ±1nm
 *3 Tolerance of measurements of luminous intensity is ±15%
 *4 Tolerance of measurements of forward voltage is ±0.1V