

■ **Features**

- High Luminous Small Package LED
- 1.8mm Tower Standard Directivity
- UV Resistant Epoxy
- Wide Operation Current 1-20mA
- Water Clear Type

■ **Applications**

- Small Area Illuminations
- Telephone
- Back Lighting
- General Use

■ **Outline Dimension**

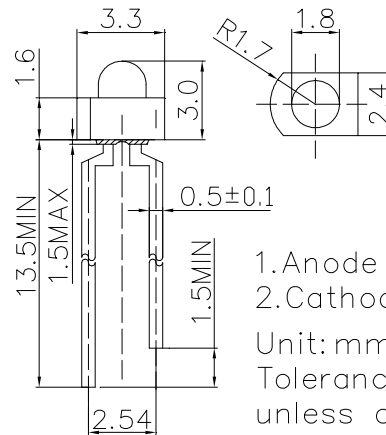

■ **Absolute Maximum Rating**

(Ta=25°C)

| Item | Symbol | Value | | Unit |
|----------------------------|-----------------|------------|----------|------|
| | | Y/O/R | W/M/B/PG | |
| DC Forward Current | I _F | 20 | 20 | mA |
| Pulse Forward Current# | I _{FP} | 100 | 100 | mA |
| Reverse Voltage | V _R | 5 | 5 | V |
| Power Dissipation | P _D | 48 | 64 | mW |
| Operating Temperature | Topr | -30 ~ +85 | | °C |
| Storage Temperature | Tstg | -40 ~ +100 | | °C |
| Lead Soldering Temperature | Tsol | 260°C/5sec | | - |



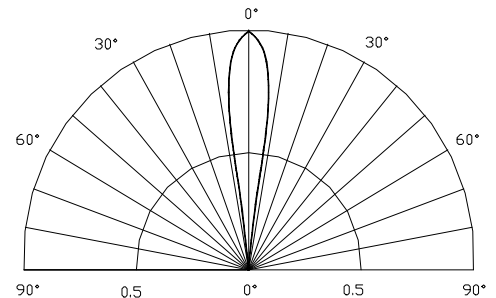



■ **Directivity**



#Pulse width Max.10ms Duty ratio max 1/10

■ **Electrical -Optical Characteristics**

(Ta=25°C)

| Part Number | Color | | | V _F (V) | | | I _R (μA) | I _v (mcd)* | | | λD(nm)*/CCT(K) | | | 2θ1/2(deg) |
|-------------|------------|----|---|---------------------|------|------|---------------------|-----------------------|---------------------|------|--------------------------------|------|------|------------|
| | | | | Min. | Typ. | Max. | Max. | Min. | Typ. | Max. | Min. | Typ. | Max. | Typ. |
| | | | | I _F =5mA | | | V _R =5V | | I _F =5mA | | | | | |
| OSW54K7311F | Cool White | W | | - | 2.7 | 3.2 | 10 | 2180 | 3000 | - | CCT:8500-18000K(X:0.27,Y:0.28) | | | 15 |
| OSM54K7311F | Warm White | M |  | - | 2.7 | 3.2 | 10 | 2180 | 3000 | - | CCT:2700-3300K(X:0.44,Y:0.41) | | | 15 |
| OSB5DA7311F | Blue | B |  | - | 2.7 | 3.2 | 10 | 1120 | 1560 | - | 465 | 470 | 475 | 15 |
| OSG58A7311F | Pure Green | PG |  | - | 2.7 | 3.2 | 10 | 2180 | 3000 | - | 520 | 525 | 530 | 15 |
| OSY5PA7311F | Yellow | Y |  | - | 1.9 | 2.4 | 10 | 1500 | 2000 | - | 585 | 590 | 595 | 15 |
| OSO5PA7311F | Orange | O |  | - | 1.9 | 2.4 | 10 | 1500 | 2000 | - | 600 | 605 | 610 | 15 |
| OSR5PA7311F | Red | R |  | - | 1.9 | 2.4 | 10 | 1500 | 2000 | - | 620 | 625 | 630 | 15 |

*1 Tolerance of measurements of chromaticity coordinate is ±10%

*2 Tolerance of measurements of dominant wavelength is ±1nm

*3 Tolerance of measurements of luminous intensity is ±15%

*4 Tolerance of measurements of forward voltage is ±0.1V

LED & Application Technologies

