

■Description

- Mounting hole size: 16mm
- LED light color: Yellow
- LED type: Bi-directional LED lamp beads (AC/DC)
- Protection level: IP65/IK09
- Switch combination: 1NO/1NC
- Operation type: Self-locking
- Shell material: Nickel plated brass
- Base material: Engineering plastics

■Product Picture



■Outline Dimension

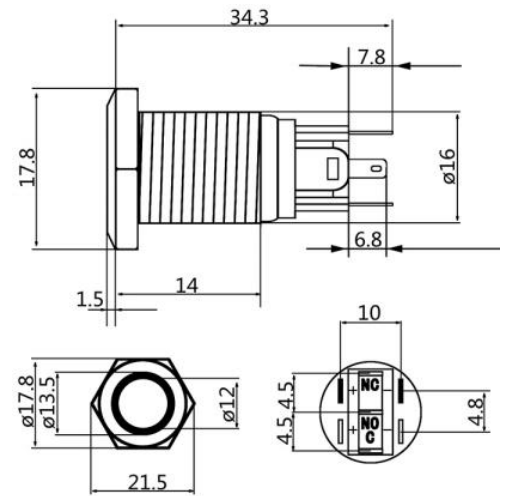

■Applications

- Industrial Automation Equipment
- Vehicle and Transportation Equipment
- Home Appliance and Commercial Equipment

Unit:mm

Tolerance:±0.30mm

■Switching Structure Description

Type	Symbol	Schematic Diagram
1NO/1NC		

*Description: Single-point slow-fast switching contact switch with three terminals

■Absolute Maximum Rating

Item	Value
Rated insulation voltage	AC 250V
Heating current	3A
Rated voltage	DC 12-24V
Resistive load	5A
Inductive load	2A
Contact resistance	≤50Ω
Insulation resistance	≥1000MΩ
Insulation strength	1000V AC
Operation stroke connected about	0.9mm
Total travel about	2.5mm
Operating temperature	-30 ~ +55°C
Storage temperature	-30 ~ +55°C